

Accelerating the Electric Era

Leading the future



DEEPAL S07

Product training

01 | Introduction



Why do so many users buy electric cars?

Once you drive an electric car, you can't go back. Apart from energy replenishment and range issues, other experiences have an absolute advantage over gasoline cars

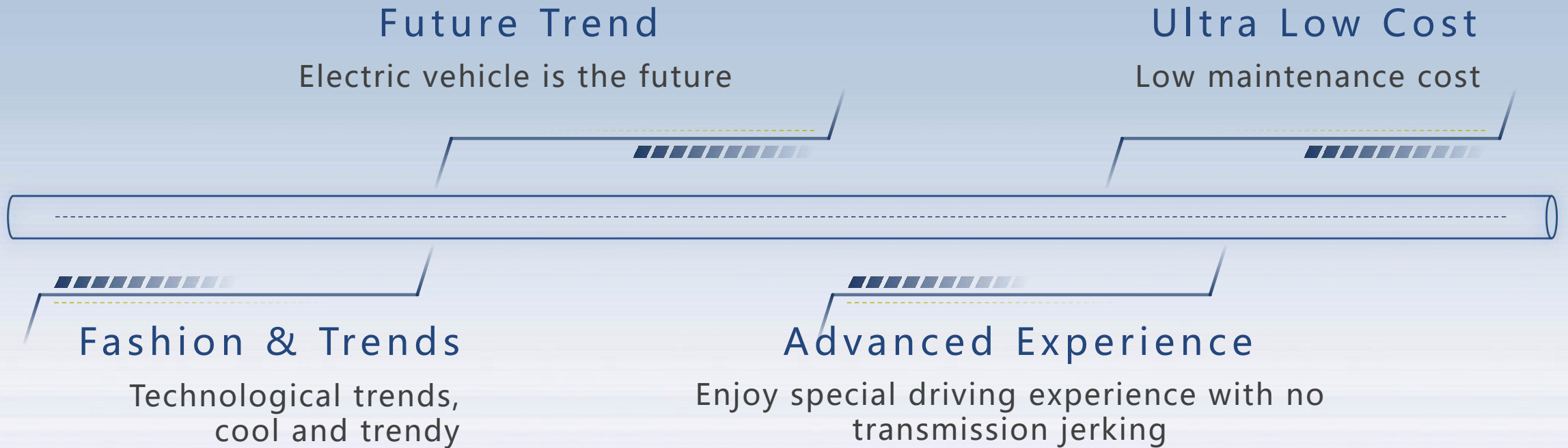

DEEPAL S07 empowers your life !

Quickly respond to your needs

Fashionable Design Superior Comfort Intelligent technology Super performance Super Safe



Vehicle positioning: **Super driving experience and pleasure electric SUV**, bring users a funny and brand new experience

Stylish design	Superior comfort	Intelligent technology	Super performance	Super Safety
<p>Technology sports appearance</p> <ul style="list-style-type: none"> ① Golden Ratio Body ② Trendy exterior design ③ Frameless car door ④ Interstellar Inspiration Appearance Colors <p>Luxury yacht interior</p> <ul style="list-style-type: none"> ① Yacht style embrace design ② Yacht style central control design ③ Suspended Sound Island ④ Intelligent hidden air outlet ⑤ 64 color wrap around ambient light ⑥ Luxury gear shift ⑦ Pioneering interior color matching 	<p>Sitting comfortably</p> <ul style="list-style-type: none"> ① Integrated seat design ② Spacious seating space in the front and rear rows <p>comfortable to use</p> <ul style="list-style-type: none"> ① Double layer soundproof glass for front windows ② 1.9 m² panoramic sunroof with electric sunshade ③ 14 speakers ④ Four door electric internal unlocking ⑤ Rear functional touch screen 	<p>Intelligent cockpit</p> <ul style="list-style-type: none"> ① Qualcomm 8155 chip ② 15.6-inch sunflower screen ③ UI interface design ④ AR-HUD holographic augmented reality system ⑤ Intelligent voice assistant ⑥ Full cockpit intelligent scenario mode ⑦ 40W wireless fast charging <p>Intelligent driving</p> <ul style="list-style-type: none"> ① IACC integrated adaptive cruise control 	<p>Super endurance :</p> <ul style="list-style-type: none"> • Extended range model have a range of up to 950KM (WLTP) • Pure electric model have a range of up to 475km (WLTP) <p>FORCE Electric :</p> <ul style="list-style-type: none"> • FORCE super e-drive • FORCE ultra Intelligent range extender 	<ul style="list-style-type: none"> ① Complete vehicle safety design ② Battery Safety: IBC Digital Battery ③ Multi layer data security: <ul style="list-style-type: none"> • Five layers of defense in depth • active monitoring • Privacy protection ④ More than 20 active security configurations ⑤ 10 million kilometers level reliable quality

02 | Value



Core selling
point 1

**Fashion
design**



Core selling point 2

Superior
Comfort

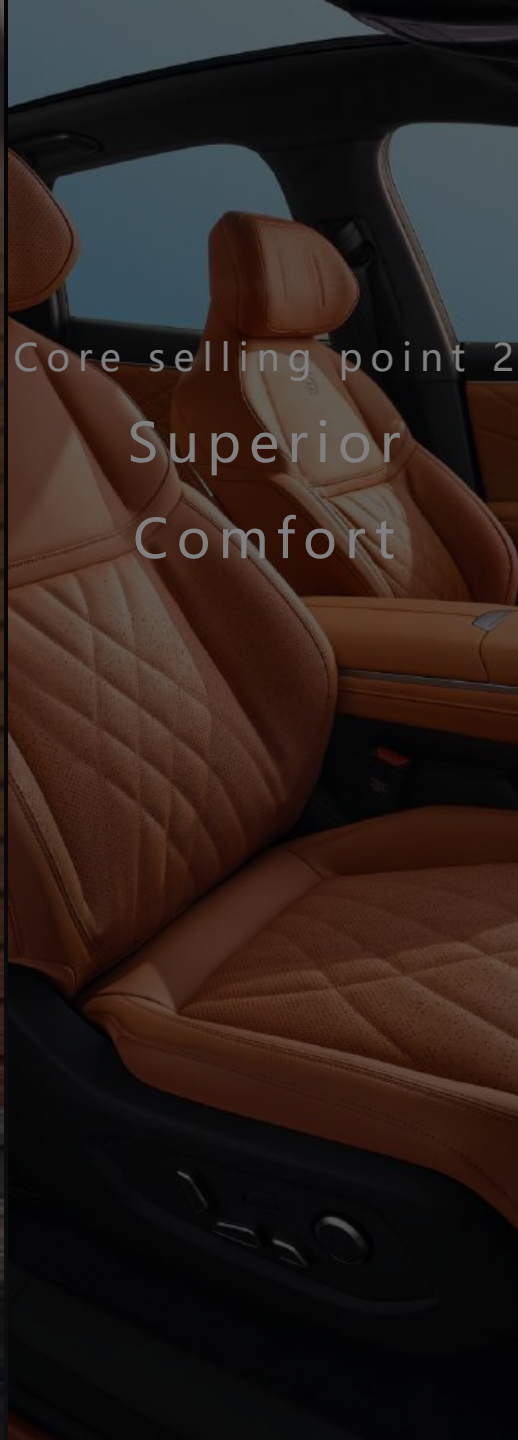

Core selling point 3

Intelligent
technology



Core selling point 4

Super
performance



Core selling point 5

Super
Safe



Golden Ratio Body

Wide body, long wheelbase **medium-sized SUV**



2900mm

The longest wheelbase in the same class

	S07	Song Plus	Model Y
Vehicle size (mm)	4750*1930*1625	4775*1890*1680	4751*1978*1624
	2900	2765	2890

Trendy Exterior Design

Fashionable exterior design



Trendy Exterior Design

Future headlight design, fashionable and technological



Star-stylish Daytime Running Light

Petal-shaped daytime running lights
Ceremonial light show

Luminous LOGO

Streamed Taillight

When lit up, it resembles the jet flame of a spacecraft launch, with a reddish texture that transforms into the light and shadow of a galaxy in the universe



Interstellar Inspiration Appearance Colors

Six colors

showcase personality and sportiness



Grey



Cyan



White



Black



Yellow



Orange



Black



Brown



White

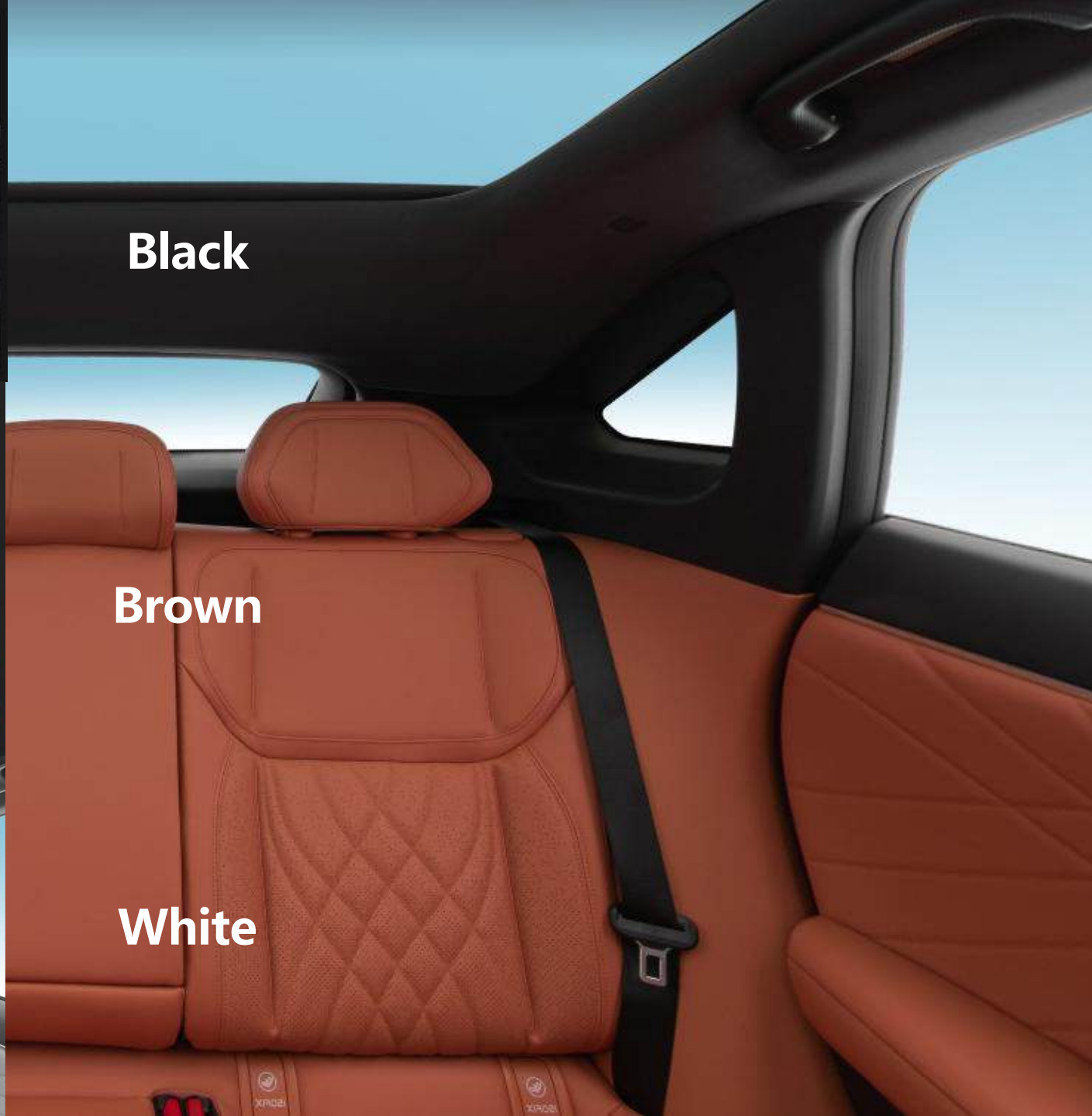

Interior Design Inspiration



“Luxury yacht”

Luxury yacht style design

"volcanic island"
AR-HUD



Suspended
'Sound Island'



15.6 inch Sunflower Screen
(unique in the same class)

wrap-around
design



Wireless charging

Yacht style
handrail

- Ultra fiber soft leather wrapping, providing a more comfortable and warm touch

Yacht style
central control

Luxury yacht style design

Luxury
gear shift

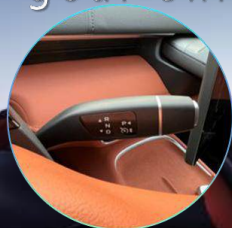

64 color wrap
around style
ambient lights

Intelligent
hidden type
air outlet

Advanced plaid seats
Advanced soft leather wrap

Core selling point 1

Fashion
design



Core selling point 2

**Superior
Comfort**



Core selling point 3

intelligent
technology



Core selling point 4

Super
performance

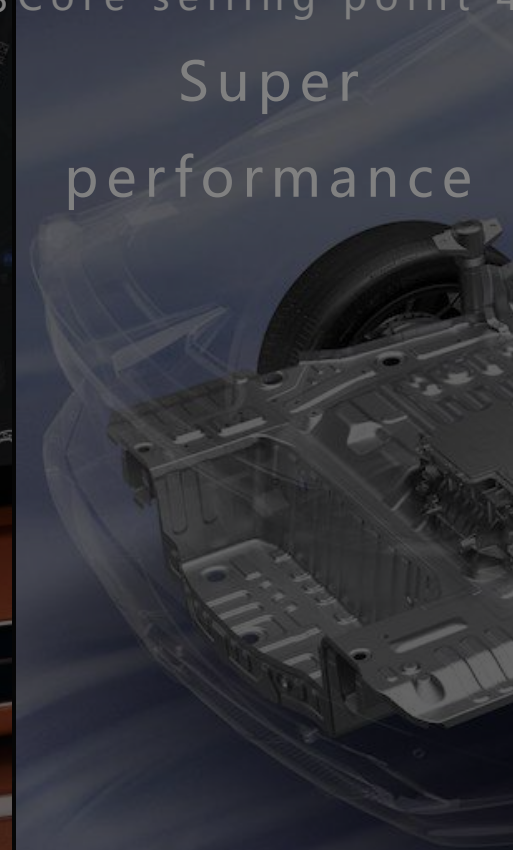

Core selling point 5

Super
Safe

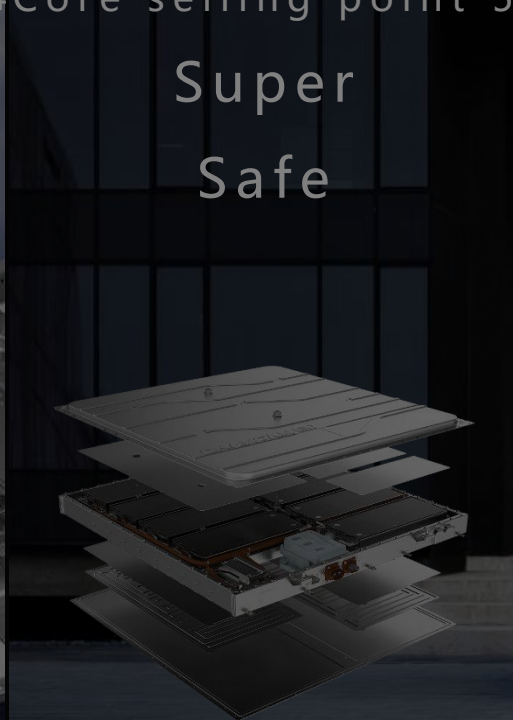

Enjoy a large space

The largest rear legroom and foot room in the same class



- Optimal headroom and legroom



- The legroom in the second row is **984mm**, which is the **largest** in the same class



- The flat floor design is also very comfortable for three people in the second row, and the foot room is enough

	S07	Song Plus	Model Y
Effective legroom in the front row	1084	1057	1037
knee space in the second row	125	100	57
Effective leg room in the second row	984	968	986

Double layer soundproof glass for front windows

Isolation of noise, comfortable ride

Good sound insulation

- Front door double-layer soundproof glass
- The front door and window glass is composed of a semi tempered glass sandwiched with a layer of **PVB film** structure, which can isolate more than **99%** of ultraviolet rays
- Compared to traditional tempered glass, **the sound insulation effect can be reduced by 3-5 dB**

High safety

- When the laminated glass breaks during a collision, the PVB film will bond the glass fragments to the film, reducing the secondary damage caused by glass fragment splashing



1.9 m² panoramic sunroof with electric sunshade

Give your family a bright environment, an imaginary window

Panoramic sunroof

- The entire series is equipped with a large panoramic sunroof and electric sunshade
- Larger opening size, better lighting, more transparent view, and warmer interior of the car

Electric sunshade

- One click for on and off, effectively blocking strong sunlight



	S07	Song Plus	Model Y
Panoramic sunroof+electric sunshade	•	•	panoramic sunroof
Sunroof area (m ²)	1.9	\	\

14 speakers

High quality audio-visual enjoyment

Loudspeaker scheme

loudspeaker	high pitch	bass	center-channel	rear surround	head rest	heavy bass
number	4	4	1	2	2	1

High fidelity sound effects

- Live on site: with better linear performance
- Concert Hall: Solidify parameters for real car tuning, presenting the best surround effect; (In this mode, the sound field and equalizer cannot be adjusted)
- Cinema mode: By simulating the viewing experience of a cinema, a highly atmospheric sound effect mode is tuned



	S07	Song Plus
Number of speakers	14	9
Power Amplifier	•	—

Touch screen at the second row

Thoughtful and comfortable



Air conditioning temperature and air volume control



Sunshade adjustment



Boss button

Diversified storage spaces

Flexible storage, convenient and practical



- ① 10L supersize armrest box
- ② Rear trunk, meeting the needs of SUV users
- ③ Front luggage compartment (EV models only) 125L, the largest in its class, can hold a 22 inch suitcase

	S07	Song plus	Model Y
Passenger compartment	26	25	21
Number of suitcases	2	1	2
Front luggage compartment	125L	—	117L

Core selling point 1

Fashion
Design



Core selling point 2

Superior
Comfort

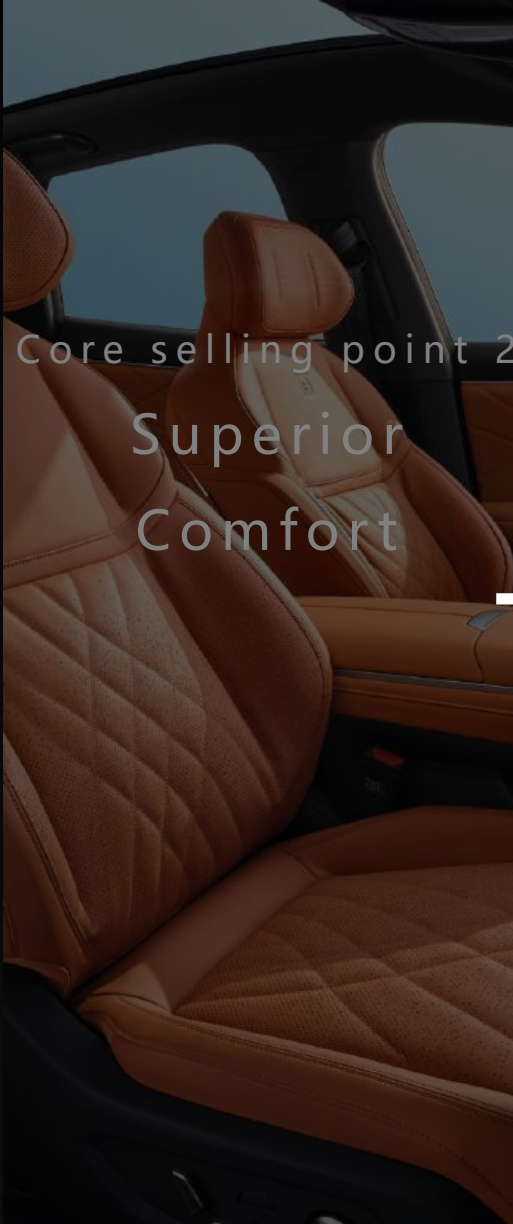

Core selling point 3

Intelligent
Technology



Core selling point 4

Super
Performance

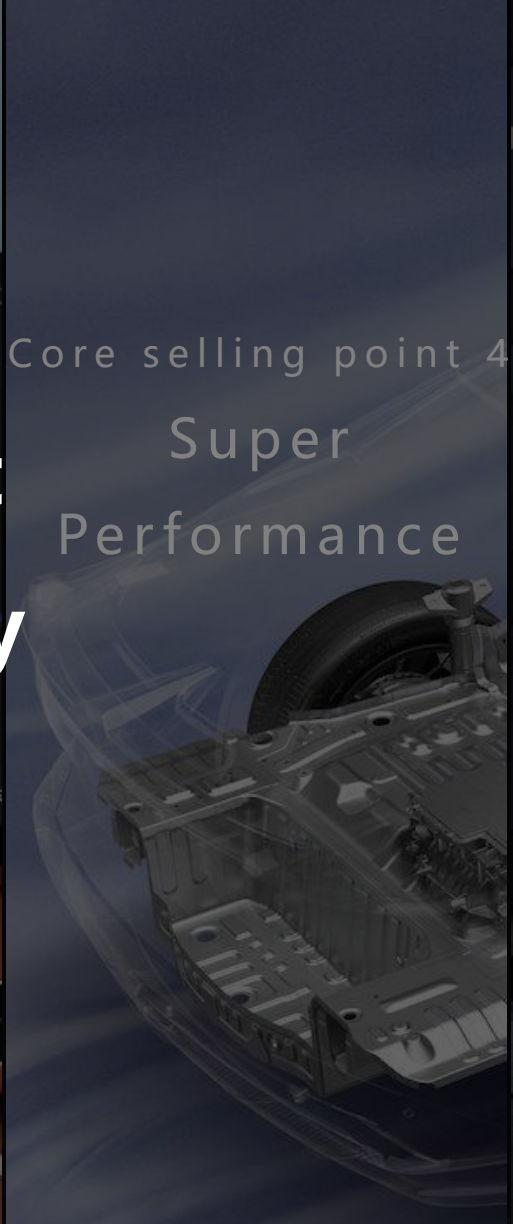

Core selling point 5

Super
Safe

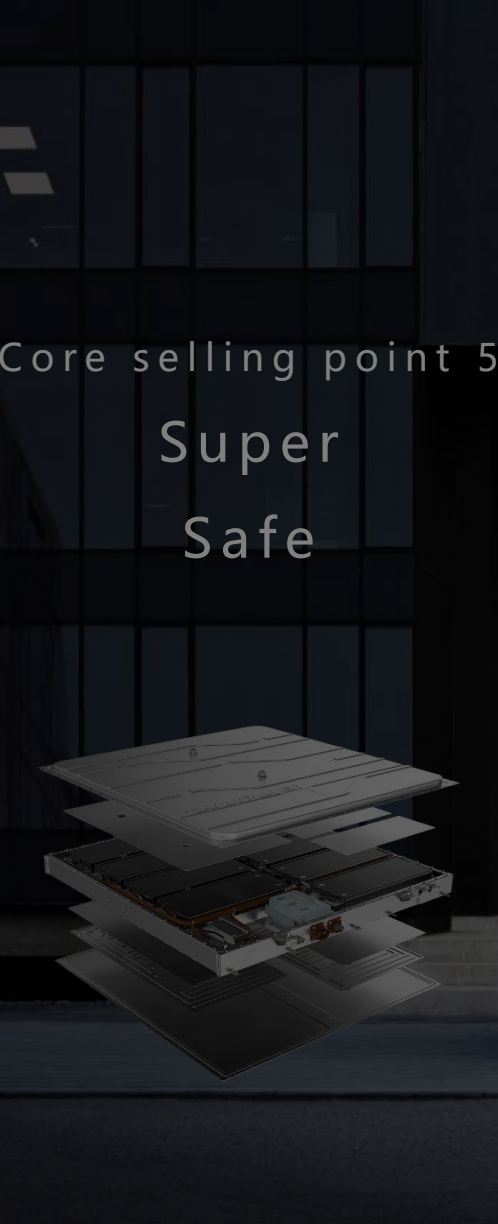

Qualcomm 8155 chip

The top tier automotive chip in the industry

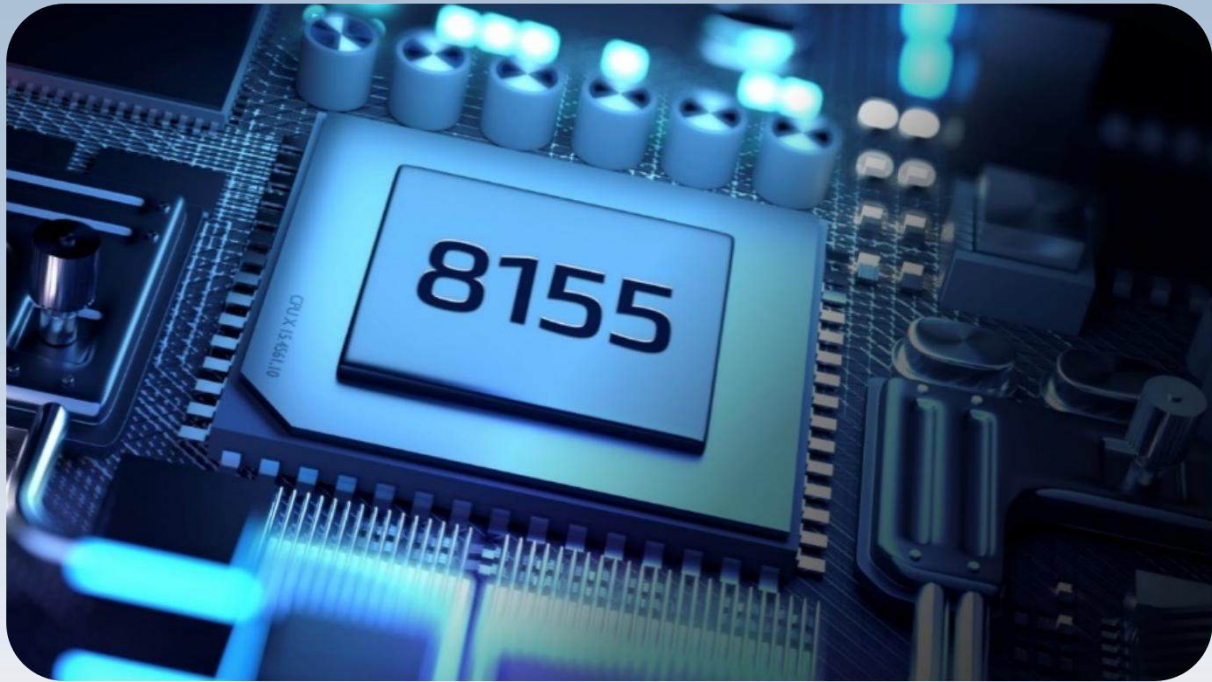

Super powerful computing power

- 7nm process
- **Twice** the computing power and **1x** the image processing compared to 820A

Second level response

- The response speed of the central control screen is less than **0.2s**
- APP opening speed < **1s**
- Face non-sensory recognition time: **1~1.5s**

Multitasking

- Front row **two screens interaction** (center console screen+AR-HUD)
- **Multi-scene operation at the same time**, ultra-high collaborative processing, reducing CPU usage

15.6-inch sunflower screen

Highly integrated , intelligent turning



High parameter

- 15.6 inch
- resolution ratio 1920*1080

Sunflower screen

- Support the **left and right** deflection 15°, the position is adjustable
- Intelligent rotation
 - Automatic turning to driver or passenger

Great material

- Integrated **magnesium aluminum alloy rear shell**
- Borderless suspended glass cover plate
- AG anti glare film, AR anti reflection film, AF anti fingerprint film

UI interface design

Beautiful, practical, and easy to operate

Integrated instrument style

- Instrument function is Integrated on the central control screen
- No physical instrumentation, better vision ahead for the driver
- **Quick operation interface: Swipe right on the leftmost side of the screen for quick access to commonly used functions**
- Scene reconstruction, unfolding and folding of cards

Co-pilot shares control

- The shortcut control card can be flipped left and right

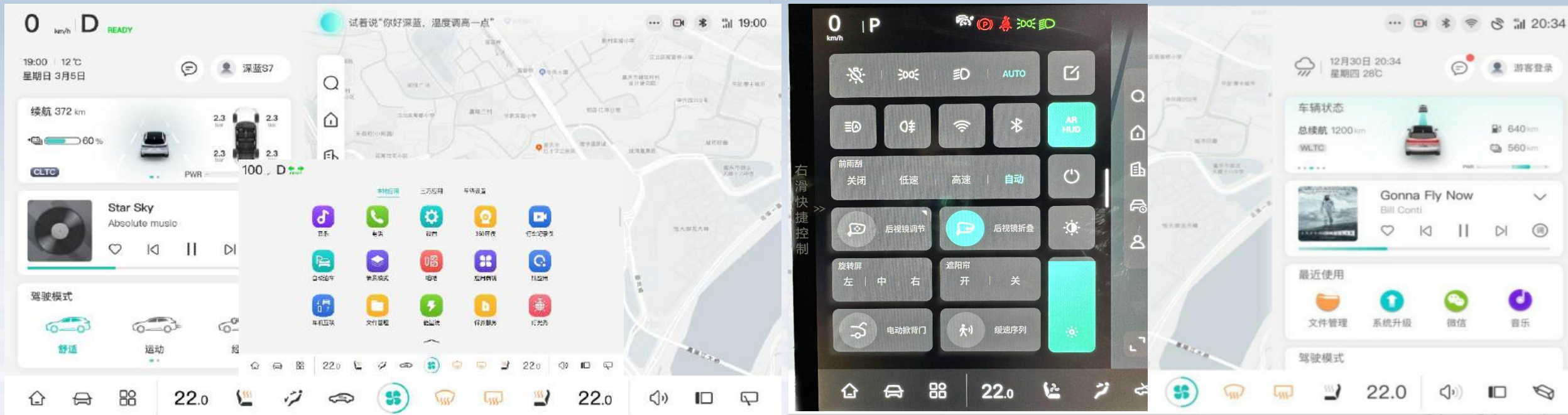

AR-HUD holographic augmented reality system

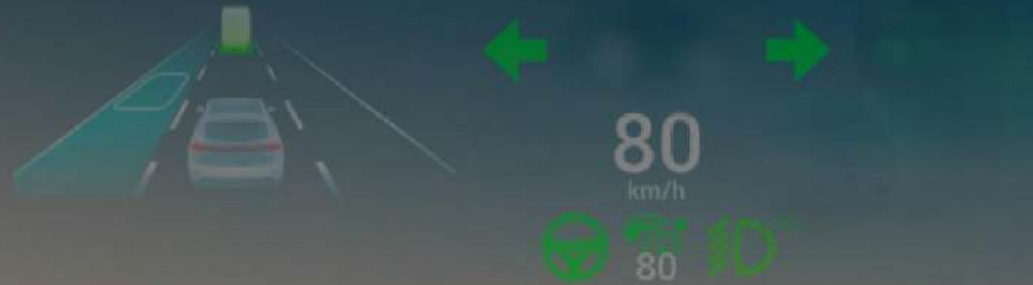

AR-HUD

Wide projection area | 53 inches (7.5 meters for optimal imaging visual distance)

Customized display content: indicator lights, pedestrian and vehicle markings

Anti-shake technology: industry-leading

Wireless charging

Efficient charging, fully charged on the way



① Wireless charging

② Equipped with ventilation function to cool down the phone during use

③ Enough space for two phones, convenient for charging and placement

Core selling point 1

Fashion
Design



Core selling point 2

Superior
Comfort

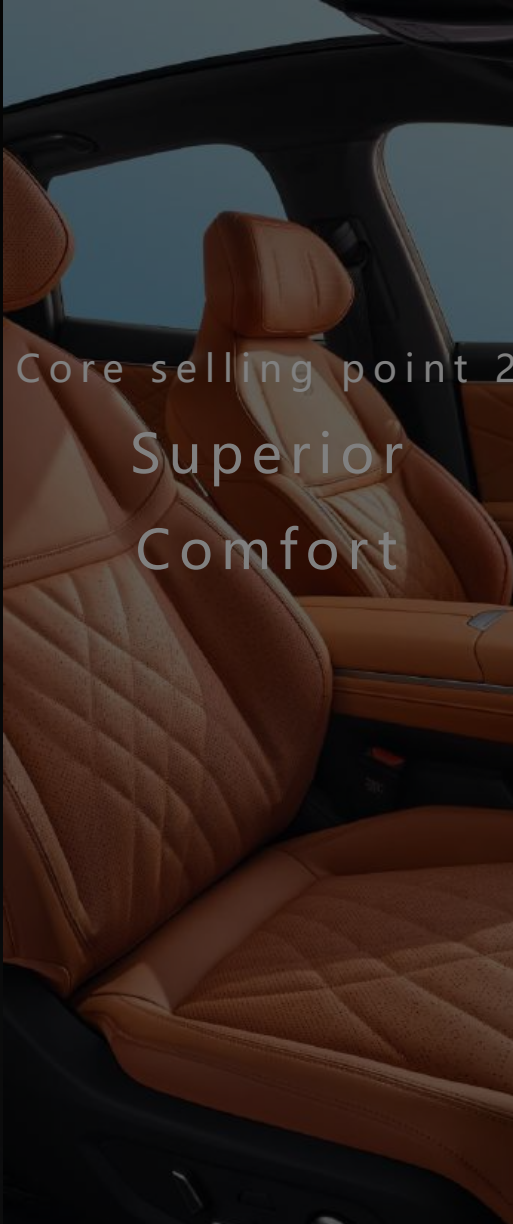

Core selling point 3

Intelligent
Technology



Core selling point 4

**Super
Performance**



Core selling point 5

Super
Safe

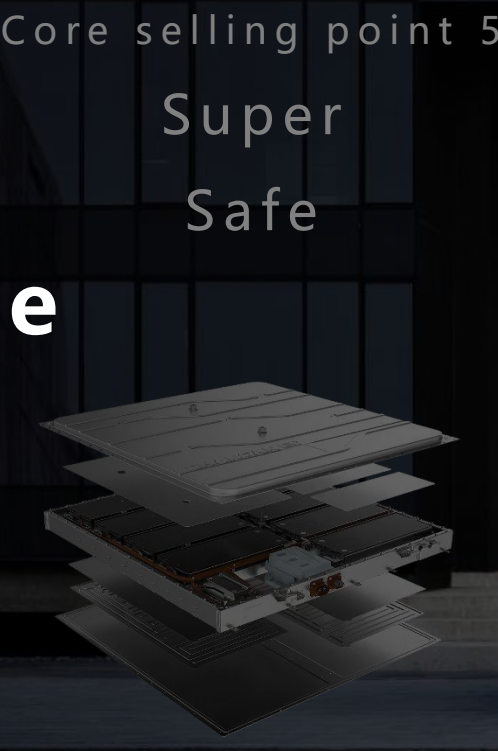

EPA1 electric digital platform

Electric digital platform

High efficiency

Ultimate electric drive efficiency of the dynamical system

- Changan's new generation of ultra integrated electric drive with a maximum efficiency of **95%**
- **The world's first** micro core high frequency pulse heating
- The first mass-produced autonomous range-Extended system

High performance

Rear wheel drive

- Rear wheel **drive+H-arm multi link**
- Ultimate driving performance tuning
- The latest generation of dual redundant braking system

High intelligence

Three domain control E/E architectures
SOA service expansion

- Intelligent vehicle domain controller "Changan Smart Core "
- High computing power cockpit domain controller
- all domain Extremely fast OTA

High security

Three-layer security architecture
Core-car cloud security

- Battery Safety: **iBC Digital Battery Manager**
- Data Security: 5+1 Information Security and Privacy Protection

Super e-drive

World-class electric drive system, Highest electric drive efficiency in the industry

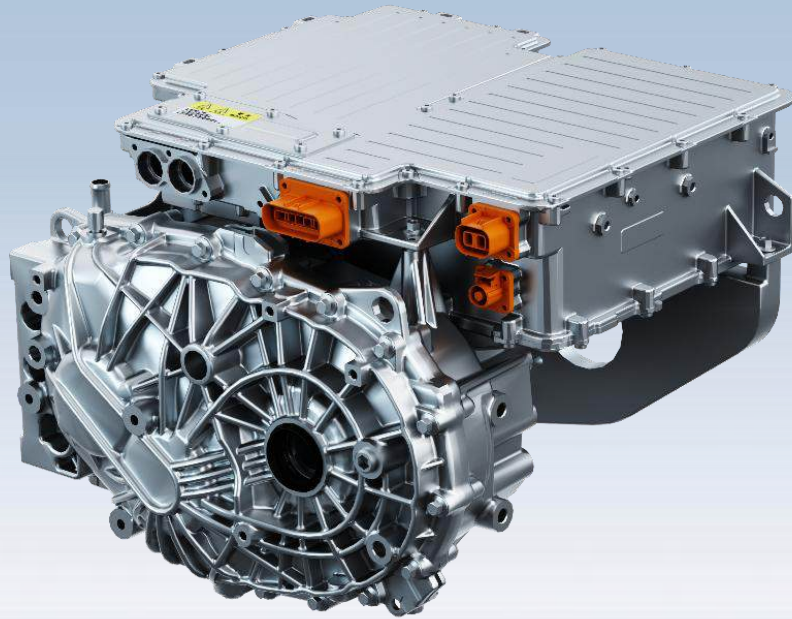

Highly integrated

Super efficiency

Maximum **95%** electric drive assembly efficiency, the highest in the industry (the mainstream level of the industry is about 85%)

S07 Energy consumption for 100 km is **as low as 19.4KW.h(WLTP)**

Super power

175KW peak power, **320N. m** peak torque

Super Silent

FORCE e-drive 1 meter average sound pressure level **<78dB (A)**, leading the industry

Super reliable

Repeatedly accelerating from 0-100km/h for more than **10 times** without attenuation

Ultra intelligent range extender

Enjoy pure electric driving without worrying about mileage

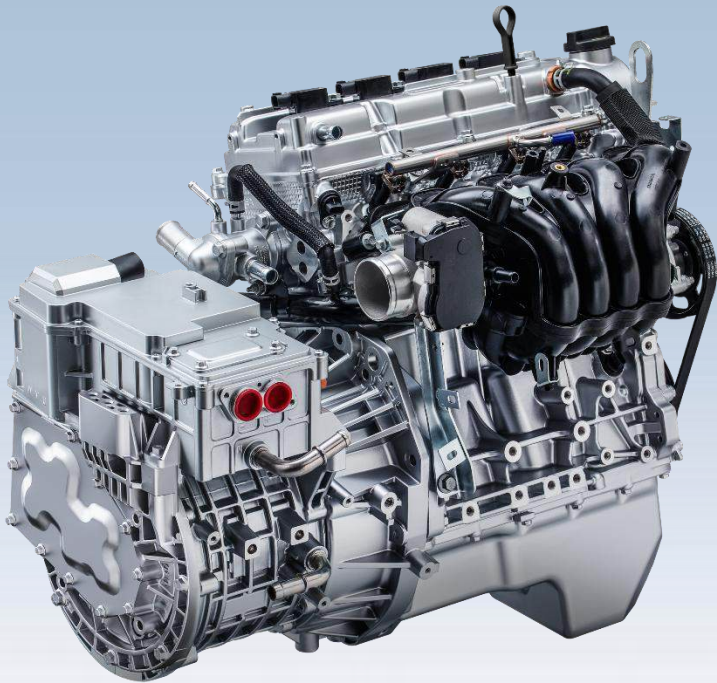

Silence

- NVH technology allows the range extender to **start stop and operate silently** during driving, providing you with a pure electric car driving experience
-

Energy saving

- The maximum efficiency of the generator is **96%**
-

Performance data of pure electric vehicle

The strongest in the same class No mileage anxiety



Super Endurance

- EV: Pure electric vehicle with a range of 475km (WLTP);
- REEV: Pure electric range 160km/comprehensive range up to 950km(WLTP)

Super Power

- EV: 160KW;
- REEV: 175KW;

Core selling point 1

Fashion
design



Core selling point 2

Superior
Comfort



Core selling point 3

Intelligent
technology



Core selling point 4

Super
performance



Core selling point 5

**Super
Safe**

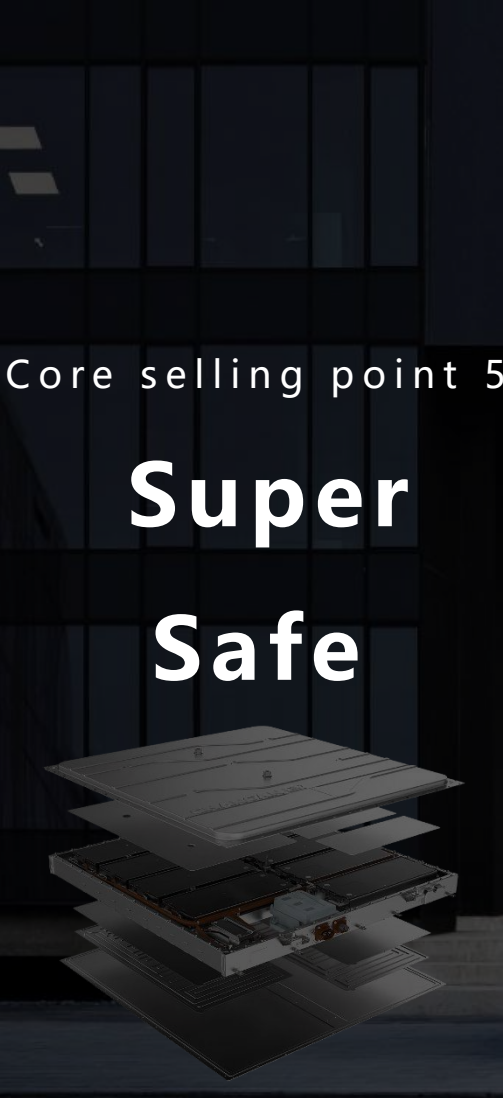

Comprehensive vehicle safety

360 ° Security Protection

Wrap-around body

Wrap-around body structure
360 ° protection for your safety

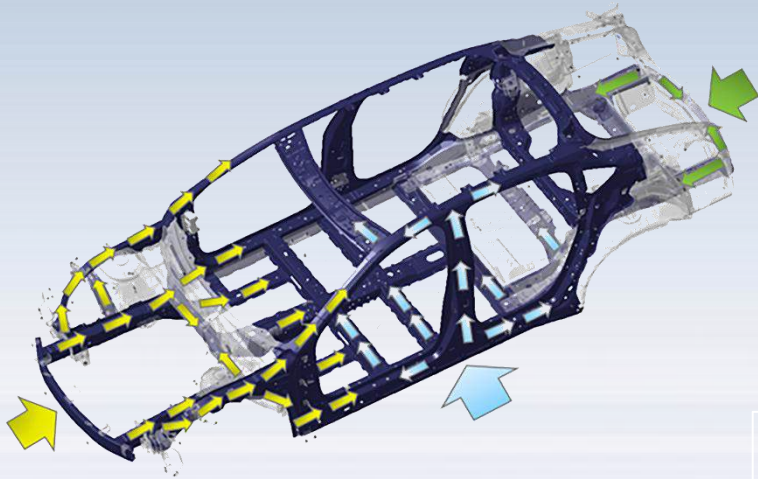

Battery protection

The battery anti-collision front beam effectively reduces the battery collision damage, and the aluminum profile crushing can effectively deal with the side impact and protect the battery safety in all aspects

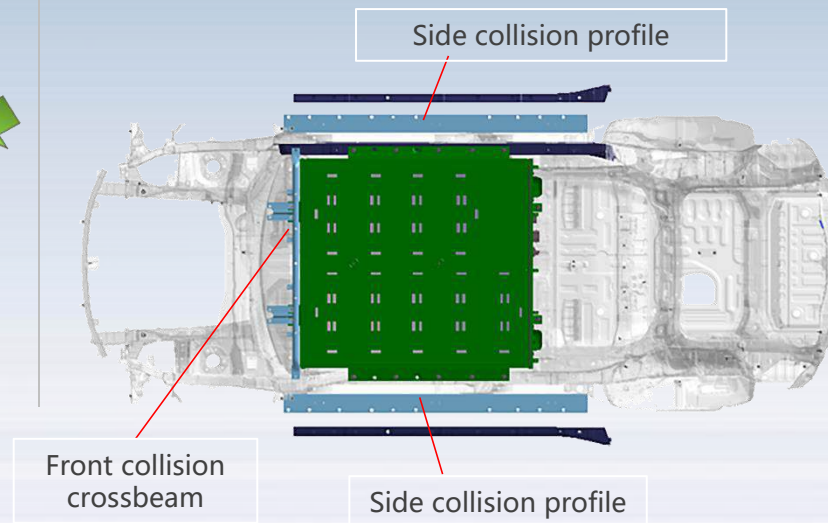

Battery Safety: iBC Digital Battery Manager

Avoid battery thermal runaway

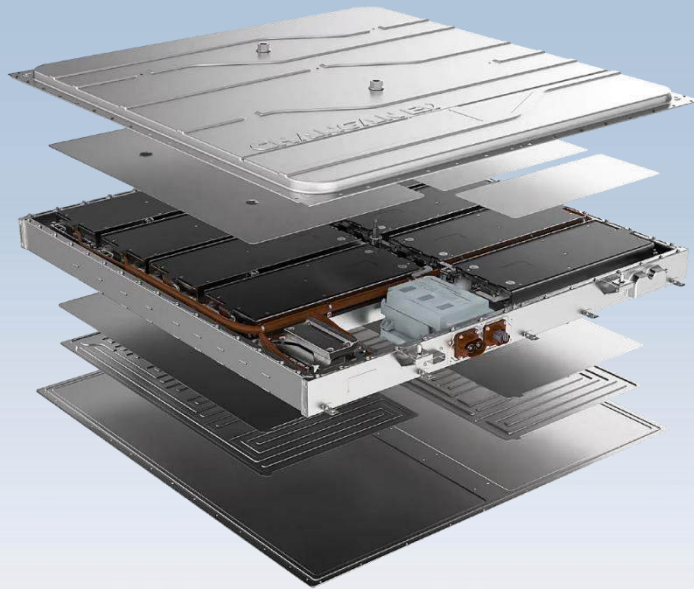

392 patents

Digital pre control management

- Preferred battery cells and digital process control: Select battery cells that meet the requirements from **top suppliers** worldwide, with **48 processes** and **1196 standards strictly controlled** to ensure high-quality battery cells
- Dual monitoring of vehicle and cloud BMS: **48-hour** warning monitoring with an **accuracy rate of 99%**; Accurately predict battery SOC value, improve range, reduce energy consumption, and enhance power smoothness

Digital temperature control management

Aerospace grade full battery insulation technology	Efficient heat dissipation through alcohol cooling	Transient pressure relief technology	Overpressure seal control	Full-Domain short-circuit prevention technology	Directional pressure sensing and emission of high-temperature gases	Full time temperature sensing alarm
isolate the high temperature above 1200°C	Capable of dissipating heat up to 100kJ/min	Pressure relief capacity: maximum 8000L/min	The world's first roller press box body;1000Mpa high-strength steel; temperature resistant 800 °C silicon-based sealing medium	10 millisecond instantaneous power-off protection; Insulating protective materials can withstand high voltage of 20000 volts	Directional rear exhaust temperature; Design of dedicated exhaust channels for isolation zones	Full time perception, microsecond level automatic wake-up

Reliable quality-10 million kilometers

High quality, high guarantee, high safety

High mileage testing

- Accumulated **10 million** miles for testing and over 30 road conditions
- Intelligent driving test (accumulated over **500000** test miles)
- Three extreme environmental tests
 - ① **Minus 40 °C** (Stability testing of vehicle power, battery, thermal management system, and electronic devices)
 - ② **50 °C high temperature** (Verification tests for driving performance, vehicle thermal management, air conditioning system, powertrain, etc)
 - ③ **High altitude above 4500m** (High altitude power performance, vehicle braking performance and other verification tests)
- **Battery testing** (passed rigorous testing of 1633 items in 44 categories)

High quality guarantee

- **The DEEPAL automotive validation system** includes 20 system tests, with a total of **862** complete vehicle level tests, **1283** system level tests, and **over 3000** component level tests, covering the entire vehicle comprehensively



Marketing Script

Vehicle positioning: Electric SUV with great driving experience

Super sensation: Beyond your senses

Driving pleasure: Rear wheel drive driving pleasure

Electric: Pure electric driving experience

SUV: Superior mid size SUV

1 core technology: super extended range (pure electric drive, Long endurance, low energy consumption)

2 product value: high facial attractiveness, high configuration

FORCE ultra Intelligent range extender

- The Deepal S07(the extended range version) adopts the "Super Range extender" technology, and the range extender operates **without any sensation** throughout the entire range, providing you with a silky **pure electric driving experience**. You are welcome to **take a test-drive and experience it for yourself**. The pure electric range is 160kilometers, and the comprehensive range is 950 kilometers. With only **one charge per week**, 99% of urban commuting and surrounding outings can be completed. The comprehensive fuel consumption is very low. The pure electric rear wheel drive **surpasses BMW's** driving pleasure, and you are worth a try!

High facial attractiveness

- The Deepal S07 is a mid size SUV with a golden ratio body design, a length of 4750mm, the widest body in its class at 1930mm, a super long wheelbase of 2900mm, frameless doors, and electric hidden door handles. Adopting star energy petal daytime running lights, star flame through taillights with luminous logos and other top flow light group designs, the stylish and technological appearance is immediately appealing, **trendy and fashionable**, and **will not go out of style for ten years!**

- Luxury yacht wrap-around cockpit, integrated seats and comfortable wrapped leather seats. If compared with ordinary seats, this is the difference between **Simmons and hardboard beds**. 64 color wrap around ambient lighting, floating sound island, and spacious rear legroom. Every design is meticulously crafted, allowing you and your family to enjoy a luxurious and comfortable atmosphere inside the car.

High configuration

- **The standard configuration of DEEPAL S07 is simply high configuration**, and the product competitiveness is overwhelming, for example ,it is equipped with the industry's top tier Qualcomm 8155 chip, upgraded with AR-HUD, the only 15.6-inch sunflower screen in the industry, the strongest voice interaction in the car's infotainment systems, and more than 10 intelligent scenario experience modes for the entire cabin. It also features **luxurious gear shift design**, 14 high fidelity Well-Known brand speakers, a 1.9-meter panoramic sunroof with electric sunshades, L2 level intelligent driving assistance, and other top-level configurations. S07, with its strongest configuration at this level, has launched a **dimensional reduction attack** on all competitors, compared to other electric vehicles transformed from traditional fuel vehicles, the difference is like the difference between **smartphones and keyboard phones**.
- DEEPAL S07 features comfortable seats in both the driver's and passenger seats, with a unique integrated seat belt for the passenger seat, making it safer for the passenger to lie down while driving compared to other vehicle models. Start enjoying your **private first-class cabin!**
- If you are considering a gasoline powered car and want to refuel and charge conveniently, but are troubled by restrictions on driving and bridges, our DEEPAL S07 **super extended range version with super driving experience and pleasure** is particularly suitable for you!
- If you are a young fashionista and want to experience the latest technological trends, DEEPAL S07 can **exceed your needs!**

Together
with
DEEPAL



Create
the
future